



microTargeting™ Platform NeuroBlate® Adapter

Directions For Use

L011-74 (Rev E0, 2018-03-09)

Contains directions for the following product:
66-WP-NB

www.fh-co.com



FHC, Inc.
1201 Main Street
Bowdoin, ME 04287 USA
Fax: +1-207-666-8292
www.fh-co.com



FHC Europe
(TERMOBIT PROD srl)
42A Barbu Vacarescu Str, 3rd Fl
Bucharest 020281 Sector 2
Romania

FHC Latin America
Calle 6 Sur Cra 43 A-200
Edificio LUGO Oficina 1406
Medellin-Colombia



24 hour technical service:
1-800-326-2905 (US & Can)
+1-207-666-8190

Table of Contents:

Indications for use and Intended use	4
Symbol Key	4
Cautions	4
Warnings	5
Inventory	5
Cleaning	6
Sterilization	6
Specifications	6
Use Cases	7
Pre-operative Planning	7
For use with Monteris Advanced Probe Driver (APD)	7
For use with Monteris Mini-bolt and Robotic Probe Driver	8
Surgical Procedure	9
Using Monteris Advanced Probe Driver	10
Using Monteris Mini-Bolt and Robotic Probe Driver	11















Indications for use:

The WayPoint™ Stereotactic System is intended to be used with commercially available stereotactic systems for neurosurgical procedures which require the accurate positioning of microelectrodes, stimulating electrodes, or other instruments in the brain or nervous systems.

Intended use:

The microTargeting™ Platform NeuroBlate® Adapter is intended for use by neurosurgeons in standard operating room environments with the microTargeting Platform, the WayPoint Surgical Kit AND the Monteris NeuroBlate® System to perform laser ablation procedures.

Symbol Key

	WARNING / Caution, consult instructions for important cautionary information		Medical device manufacturer, as defined in EU Directives 90/385/EEC, 93/42/EEC and 98/79/EC.
	Consult the instructions for use		Telephone number
	Do not re-use; intended for one use on a single patient, during a single procedure		Authorized Representative in the European Community
	Medical device that is not to be re-sterilized.		European Conformity. This device fully complies with MDD Directive 93/42/EEC and legal responsibilities as a manufacturer are with FHC, Inc., 1201 Main Street, Bowdoin, ME 04287 USA.
	Medical device that has not been subjected to sterilization process		In reference to "Rx only" symbol; this applies to USA audiences only
	MR Safe - item poses NO known hazards in all MRI environments		Indicates the catalog number
	microTargeting Platform product		Indicates the serial number
Rx only	CAUTION - Federal law (USA) restricts this device to sale by or on the order of a physician.		

microTargeting™ and WayPoint™ are trademarks of FHC, Inc.





Cautions:

Rx only CAUTION: Federal law (USA) restricts this device to sale by or on the order of a physician.

CAUTION: Use with other components or systems is not authorized and may result in mechanical failure or injury.

CAUTION: Always check the securing thumbscrews and knobs to prevent loosening and movement of the adapter and other components.

Warnings:

-  **WARNING:** The microTargeting Platform NeuroBlate® Adapter is shipped non-sterile and must be sterilized before use.
-  **WARNING:** Prior to use, the microTargeting Platform NeuroBlate® Adapter should be completely assembled and correct operation verified to ensure that all components function properly. Improper set-up of equipment may lead to serious patient injury.
-  **WARNING:** The microTargeting Platform NeuroBlate® Adapter is not validated for use with alternative sterilization protocols, and FHC does not recommend or endorse their use. Users with questions regarding this safety issue should contact FHC's Technical Service Department at 1-207-666-8190.
-  **WARNING:** The microTargeting Platform NeuroBlate® Adapter is for single use only. Resterilization could result in structural integrity, mechanical degradation and/or heightened biological growth. The validated Sterility Assurance Level (SAL) cannot be guaranteed with reuse.

Inventory:

66-WP-NB : microTargeting Platform NeuroBlate® Adapter

The positioner, mounted into a hub from the WayPoint Surgical Kit in a microTargeting Platform, can be used to support the Monteris Advanced Probe Driver or hold Monteris instrument guides for placing the Monteris mini-bolt used to attach the Monteris Robotic Probe Driver.

Additional items required for operation, available separately:

MP-KIT-P-U3: microTargeting 3-Leg Unilateral Platform or

MP-KIT-P-U4: microTargeting 4-Leg Unilateral Platform or

MP-KIT-P-BI: microTargeting 4-Leg Bilateral Platform

A patient-specific platform designed for each surgical procedure that is held to skull mounted fiducial anchors using standoffs and thumbscrews.

66-WP-SKS: WayPoint Surgical Kit

Pre-sterilized, single-use tools and parts used to attach platform to fiducial anchors and hubs to support positioner.

66-WP-PL: WayPoint Planner or

66-WP-NV (x.x): WayPoint Navigator

FHC microTargeting Platform planning and design software, required to plan, verify and submit patient specific microTargeting Platform plan for production.

66-WP-IKS: WayPoint Disposable Implantation Kit

Provides tools and parts needed for the anchor implantation and scanning procedures. Refer to the appropriate directions for details.

Additional items required for operation, available separately from Monteris Medical:

NBD-01: Monteris Advanced Probe Driver

Various: Appropriate Laser Delivery Probe

For use with Monteris Advanced Probe Driver.

CMB022-SD: 6mm specialized driver for 2.2 mini bolt with insert adapter or

CMB-SD: 6mm specialized driver for 3.3 mini bolt with insert adapter

Various: Appropriate Monteris mini-bolt

RPD-01: Monteris Robotic Probe Driver

Various: Appropriate Laser Delivery Probe

For use with Monteris Mini-bolt and Robotic Probe Driver.

Optional Accessories: None

Cleaning:

The microTargeting Platform NeuroBlate® Adapter components should not be cleaned prior to use.

Sterilization:

The microTargeting Platform NeuroBlate® Adapter should be wrapped in 2 layers of 1-ply polypropylene wrap and sterilized using the following parameters:

Method	Protocol	
Steam	Gravity wrapped: (in 2 layers of 1-ply polypropylene wrap ^[1]) Exposure time: 10 minutes at 132°C (270°F) [1] Cycle was validated using Halyard Health H600 wrap	Prevacuum wrapped: (in 2 layers of 1-ply polypropylene wrap ^[2]) Preconditioning Pulses: 3 Exposure time: 4 minutes at 132°C (270°F) Minimum Dry Time: 40 minutes [2] Cycle was validated using Halyard Health H200 wrap
Sterrad™	Sterrad™ 100S full cycle	

Specifications:

- Single-use
- Material: DuraForm PA or PA 2200 (Nylon), PEEK thumb knob
- Compatible with FHC platform adaptor hubs (70-FA-SF or 66-WP-SKS)
- 10mm mount for Monteris APD and Monteris Instrument Adapters

Use Cases:

The microTargeting Platform NeuroBlate® Adapter supports:

1. Use as a stereotactic guidance and support for the Monteris Advanced Probe Driver (APD). The microTargeting Platform and microTargeting Platform NeuroBlate® Adapter remain in position during the ablation procedure.
2. Use as a stereotactic guide to place Monteris mini-bolt used to mount the Monteris Robotic Probe Driver (RPD). Once the mini-bolt is placed the microTargeting Platform is removed and the RPD is attached directly to the mini-bolt.

Each use requires a different combination of Monteris parts and tools and has a separate procedure.

Pre-operative Planning:

1. Select 3-leg or 4-leg unilateral or bilateral microTargeting Platform that is appropriate for specific surgical needs.
2. Place anchors in appropriate location for selected microTargeting Platform.
3. Assure the following clearances are provided for proper operation of the selected Monteris use case.

For use with Monteris Advanced Probe Driver (APD):

- A. Assure that there is at least 20.7mm from the bottom of the platform to the top of the scalp for clearance of the APD shaft.
- B. Avoid excessive platform height which may limit travel of the laser probe driver in smaller MRI bores.

The figure below shows a microTargeting Platform with a height of 120.0mm (right), which is equivalent to the distance from the PDP to the top of the MRI marker in the main ball of the Monteris AXii5 frame (left).

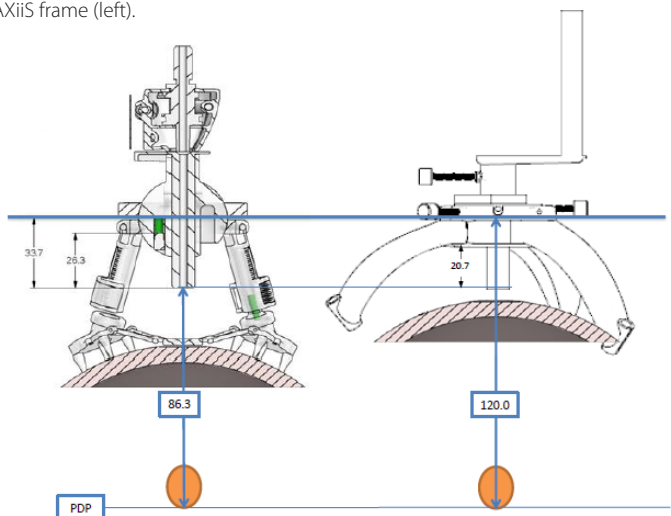

For use with Monteris Mini-bolt and Robotic Probe Driver:

- A. Assure that there is at least 60.0mm clearance from the bottom of the platform to the top of the skull to provide room for the mini-bolt below the fully seated Monteris Insert Adapter.

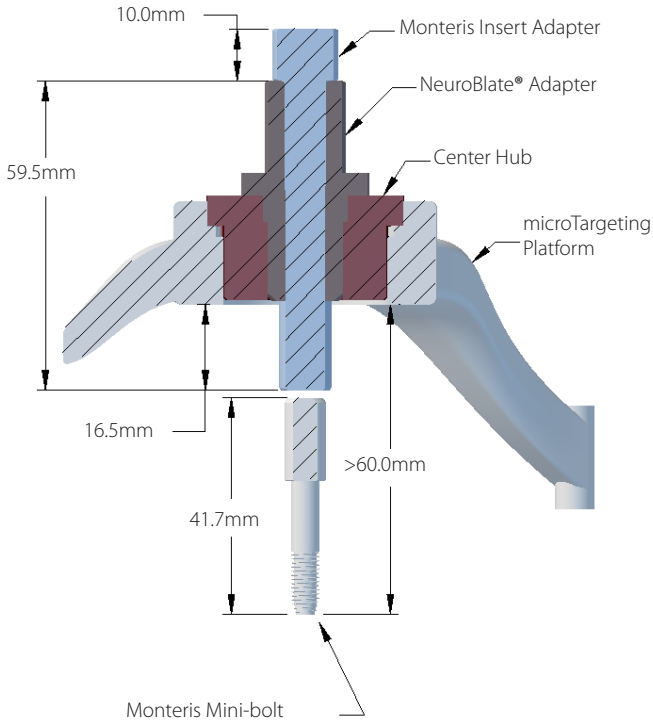

Surgical Procedure:

1. Remove and discard the two positioners (circled below) from the sterile WayPoint Surgical Kit.

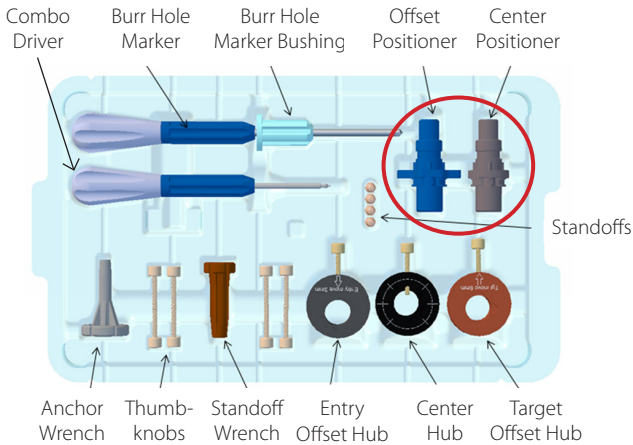

2. Attach platform to previously implanted fiducial markers using stand-offs and thumbknobs included in the sterile WayPoint Surgical Kit. Refer to the WayPoint Implant and Surgical Kit Directions for Use for details (L011-68).

3. Insert the center hub included in the WayPoint Surgical Kit into the microTargeting Platform. Secure using two thumbknobs from the sterile WayPoint Surgical Kit in two adjacent (90°) holes on the outer edge of the microTargeting Platform.

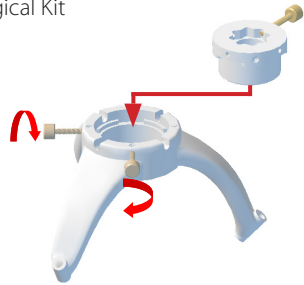

4. Insert the white positioner from the microTargeting Platform NeuroBlate® Adapter into the center hub and secure with the thumbknob.

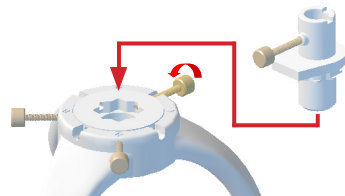

Using Monteris Advanced Probe Driver:

If not using Monteris Advanced Probe Driver go to step 10.

5. Refer to Monteris IFU to select and use appropriately sized Monteris Instrument Adapter and twist drill to create access hole in skull. Insert adapter into microTargeting Platform NeuroBlate® Adapter, drill hole, then remove instrument adapter.
6. Insert Monteris Advanced Probe Drive into microTargeting Platform NeuroBlate® Adapter, rotate to assure tabs on the bottom of the rail guide engage with notches in adapter. Secure with thumbknob.
7. Select appropriate Laser Delivery Probe for use. When used with microTargeting Platform NeuroBlate® Adapter the Laser Delivery Probe depth setting is equal to the platform height selected during planning. This value, in mm, is embossed on the platform as "TD=nnn."

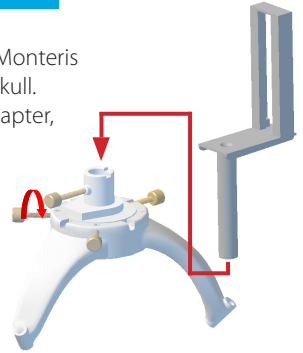

The microTargeting Platform height is equivalent to the location of the top of the beam direction fiducial marker in the Monteris AXiiiS center ball joint - refer to figure on page 7 for details.

8. Insert laser delivery probe and complete laser ablation procedure as shown in Monteris IFU.
9. Remove platform, standoff and anchors as shown in the WayPoint Implant and Surgical Kit Directions for Use (L011-68).

Using Monteris Mini-Bolt and Robotic Probe Driver:

If not using Monteris Mini-Bolt and Robotic Probe Driver go to step 5.

10. Refer to Monteris IFU to select and use appropriately sized Monteris Instrument Adapter and twist drill to create access hole in skull. Insert adapter into microTargeting Platform NeuroBlate® Adapter, drill hole, then remove instrument adapter.

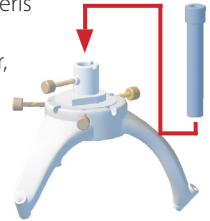

11. Insert Monteris Insert Adapter completely into the microTargeting Platform NeuroBlate® Adapter.

12. While holding the Monteris Mini-bolt below the platform slide the Monteris 6mm Specialized Driver through the Monteris Insert Adapter and into the bolt.

If needed, lift the insert adapter to allow the mini-bolt to be put into position.

13. Screw the mini-bolt into skull according to Monteris IFU.

14. Read scale of the Monteris 6mm Specialized driver at point where it exits the Monteris Insert Adapter (D1) then remove driver.

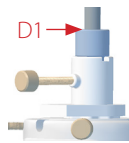

15. Read scale of the Monteris 6mm Specialized Driver at the point where driver rests on the top of the mini-bolt (D2) as shown by red line in figure. DO NOT ASSUME THIS VALUE IS ZERO.

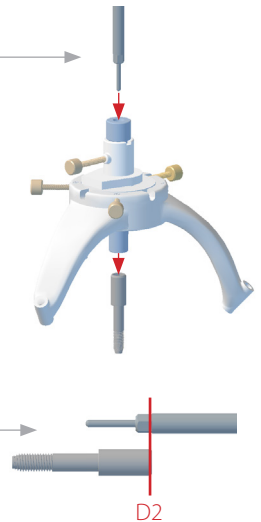

16. Calculate the bolt offset, BO, from the top of the Monteris Instrument Adapter to the top of the mini-bolt: $BO = D1 - D2$

17. Calculate the distance from the top of the bolt to target, D:
 $D = \text{platform height} + 29.7 \text{ mm} + \text{insert adapter collar height} - \text{bolt offset}$
 $D = TD + 29.7 \text{ mm} + 10.0 \text{ mm} - BO$
 $D = TD + 39.7 \text{ mm} - BO$
(see figure on next page)

18. Remove platform, standoff and anchors as shown in the WayPoint Implant and Surgical Kit Directions for Use.

19. Select appropriate Laser Delivery Probe for use based on bolt distance to target calculated above.

20. Insert laser delivery probe and complete laser ablation procedure as shown in Monteris IFU.

Surgical Procedure step 17 details:

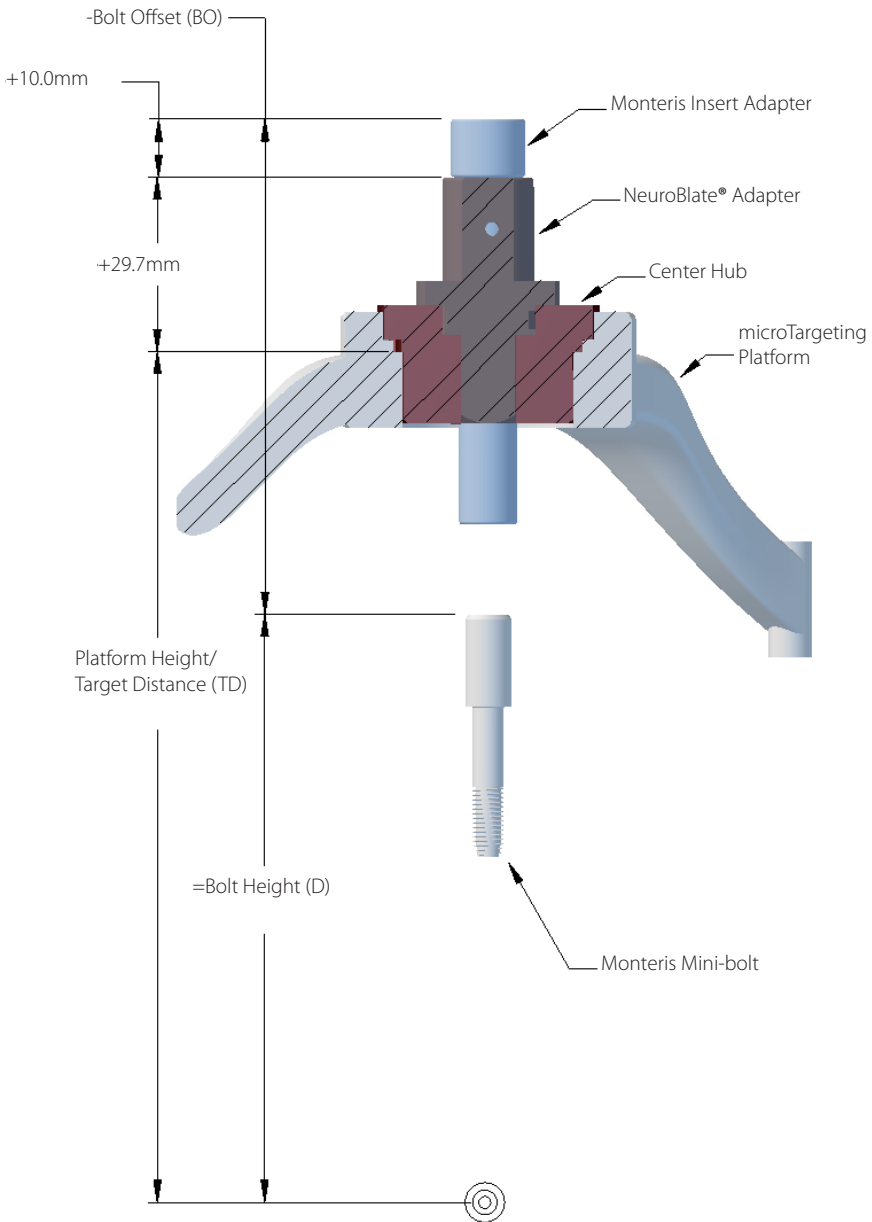

The figure above show how the distance from the top of the Monteris Mini-bolt (D) to planned target is calculated based on the platform height/target distance (TD) selected during planning.