



# WayPoint™ Inserter System

---

## Directions For Use

L011-61 (Rev H0, 2021-05-14)

---

Contains directions for the following products:

66-WP-ID-01, 66-WP-ID-02

[www.fh-co.com](http://www.fh-co.com)



FHC, Inc.  
1201 Main Street  
Bowdoin, ME 04287 USA  
Fax: +1-207-666-8292



24 hour technical service:  
1-800-326-2905 (US & Can)  
+1-207-666-8190



FHC Europe  
(TERMOBIT PROD srl)  
42A Barbu Vacarescu Str, 3rd Fl  
Bucharest 020281 Sector 2  
Romania

FHC Latin America  
Calle 6 Sur Cra 43 A-200  
Edificio LUGO Oficina 1406  
Medellín-Colombia



## Table of Contents

Indications for use and Intended use	4
Symbol Key	4
Warnings and Cautions	4
Specifications	5
Inventory	5
Storage	5
Cleaning	6
Sterilization	7
Height Chart - 130mm Inserter	8
Height Chart - 120mm Inserter extended clearance	9
Pre-Use Check	10
Illustrative Procedure: MRI implantation of Lead	12
In the MRI Environment	17
In the non-MRI Environment	18





















## Indications for use

The WayPoint™ Inserter System is intended to be used with commercially available stereotactic systems for neurosurgical procedures which require the accurate positioning of microelectrodes, stimulating electrodes, or other instruments in the brain or nervous system.

## Intended use

The WayPoint™ Inserter System is intended for use with the microTargeting™ Platform by a neurosurgeon in a standard operating room environment or a MRI suite.

## Symbol Key

	WARNING / Caution, consult instructions for important cautionary information.		Medical device manufacturer, as defined in EU Directives 90/385/EEC, 93/42/EEC, 98/79/EC and Medical Device Regulation (EU) 2017/745.
	Consult the instructions for use.		Telephone number
	In reference to "Rx only" symbol; this applies to USA audiences only.		Authorized Representative in the European Community.
Rx Only	Caution- Federal law (USA) restricts this device to sale by or on the order of a physician.		European Conformity. This device fully complies with Medical Device Regulation (EU) 2017/745 and legal responsibilities as a manufacturer are with FHC, Inc., 1201 Main Street, Bowdoin, ME 04287 USA.
	Indicates the catalogue number so that the medical device can be identified.		Indicates the temperature limits to which the medical device can be safely exposed.
	Indicates the manufacturer's batch code so that the batch or lot can be identified.		Indicates the range of humidity to which the medical device can be safely exposed.
	Indicates the serial number so that a specific medical device can be identified.		Do not re-use; intended for one use on a single patient, during a single procedure.
	The date when the medical device was manufactured.		Indicates a medical device that is not to be resterilized.
	Indicates Medical Device		Indicates a medical device that has not been subjected to a sterilization process.
	Instructions for end of life disposal.		MR Safe- the item poses NO known hazards in all MR environments
	For use with microTargeting™ Platform		

## Warnings and Cautions

 **WARNING:** Handle all components with extreme care. They may be damaged if excessive force or incorrect handling occurs.

 **WARNING:** User must examine unit prior to use to ensure it has no shipping damage.

 **Caution:** SLS components are for single patient use only. Do not reuse any single use components.

Rx Only **Caution:** Federal law restricts this device to sale by or on the order of a physician.

## Specifications

Array spacing: 2.00 mm from center

Array guide hole diameter: 1.88mm

Bushing configuration: center hole on stereotactic axis with 4 holes offset by 2.00 mm on center and orthogonal to the center hole.

### STar™ SteriSuite:

Material: Electropolished Stainless Steel

Insert: Nylabond coated Stainless Steel

## Inventory

SLS Components (part numbers 66-WP-ID-01 and 66-WP-ID-02) include:

1. Inserter
2. Lead Holder
3. Thumbknobs
4. Lead Measurement Fixture
5. Drape Support

Accessories Sold Separately:

6. 66-MP-EM / Burr Hole Marker
7. 66-WP-SW / Standoff Wrench
8. 66-WP-HW / Hex Wrench
9. 66-WP-DH / Manual Handle
10. 66-WP-CD-01 / Combination Driver
11. 66-MP-EM / Burr Hole Marker Bushing
12. 70-FA-SF-01 / STar SteriSuite Case
13. 67-00-1 / Sterilization Tray

**⚠ WARNING:** Do not reuse single use items.

**⚠ WARNING:** Metal items should not be used in the MRI environment or in the presence of an MRI magnet.

Additionally required for use:

1. 66-WP-SKS / WayPoint Disposable Surgical Kit
2. 66-AC-DC / LeadLoc
3. 66-IT-MR1 or 66-IT-MR3 / MR Lead Insertion Tube





## Storage

Store all components at temperatures between  $-34^{\circ}\text{C}$  ( $-29^{\circ}\text{F}$ ) and  $57^{\circ}\text{C}$  ( $135^{\circ}\text{F}$ ). Do not exceed  $135^{\circ}\text{F}$  for long-term storage.



## Cleaning

There are two methods to clean the components: manual or automated cleaning. Select one. **Note that SLS components should not be cleaned prior to use and should only be sterilized following the protocol on page 7.**

Method	Container	Protocol			
		Phase	Duration	Component/Notes	Detergent Type
Manual		<b>Soak</b>	5 minutes in detergent solution	Immerse all parts separated from each other. Actuate devices during soaking.	Asepti Wash Plus liquid
		<b>Wipe</b>		User detergent dampened cloth to wipe tray and insert. Use brushes to reach hard to clean areas.	
		<b>Sonicate</b>	10 minutes minimum	Tray fully loaded with parts in sonication unit with detergent	Asepti Wash Plus liquid
		<b>Rinse</b>		Reverse Osmosis/ de-ionized water	
		<b>Dry</b>		Use clean soft cloth	
		<b>OR</b>			
Automated		<b>Phase</b>	<b>Recirculation Time (in minutes)</b>	<b>Water Temperature</b>	<b>Detergent Type</b>
		<b>Pre-Wash 1</b>	2	Cold tap water	N/A
		<b>Enzyme Wash</b>	2	Hot tap water	Asepti Wash Plus or Sekusept AR
		<b>Wash 1</b>	2	65.5°C	Asepti Wash Plus or Sekusept AR
		<b>Rinse 1</b>	2	Heated tap water	N/A
		<b>Pure Water Rinse</b>	0:10	Heated	Asepti Rinse or Sekusept FNZ or Sekumatic Multiclean
		<b>Dry</b>	7	115°C	N/A

Listed are the detergents and cycles that FHC has validated. Detergents listed are from Ecolab. If other neutral or alkaline detergents are used, testing should be done by the hospital to ensure product is not damaged. Detergents should be prepared per manufacturers recommendations.

## Sterilization

-  **WARNING:** Users should be aware that the effects of unvalidated sterilization protocols could result in damage to the components and affect their functioning or performance. The components of this system are not validated for use with alternative sterilization protocols, and FHC does not recommend or endorse their use. Users with questions regarding this safety issue should contact FHC's Technical Service Department at 1-207-666-8190.
-  **WARNING:** The microTargeting™ Platform is shipped non-sterile and must be sterilized before use. Invert the platform on its hub surface with the legs pointing up during sterilization.
-  **WARNING:** Disposable surgical kit is not intended for sterilization.

### Platform and Drape Support Sterilization Instructions

Method	Protocol	
Steam	<b>Gravity wrapped:</b> (in 2 layers of 1-ply polypropylene wrap <sup>[1]</sup> ) Exposure time: 10 minutes at 132°C (270°F)  [1] Cycle was validated using Halyard Health H600 wrap	<b>Prevacuum wrapped:</b> (in 2 layers of 1-ply polypropylene wrap <sup>[2]</sup> ) Preconditioning Pulses: 3 Exposure time: 4 minutes at 132°C (270°F) Minimum Dry Time: 40 minutes  [2] Cycle was validated using Halyard Health H200 wrap
	<b>Sterrad™</b> <b>Sterrad™ 100S full cycle</b>	

### Components in SteriSuite Case Sterilization Instructions

Method	Protocol	
Steam	<b>Gravity wrapped</b> (in 2 layers of 1-ply polypropylene wrap <sup>[3]</sup> ) Exposure Time: 30 minutes at 132°C (270°F) Minimum Dry Time: 60 minutes  [3] Cycle was validated using Halyard Health H300 wrap	<b>Prevacuum wrapped</b> (in 2 layers of 1-ply polypropylene wrap <sup>[4]</sup> ) Preconditioning Pulses: 3 Exposure time: 4 minutes at 132°C (270°F) Minimum Dry Time: 60 minutes  [4] Cycle was validated using Halyard Health H400 wrap
	<b>Prevacuum wrapped</b> (in 2 layers of 1-ply polypropylene wrap <sup>[1]</sup> ) Preconditioning Pulses: 3 Exposure time: 18 minutes at 134°C Minimum Dry Time: 60 minutes  [1] Cycle was validated using Halyard Health H3 00 wrap	

## 130 mm Inserter-Height Chart

Catalog Number: 66-WP-ID-01  
(Shown with MR Lead Insertion Tube 66-IT-MR1)

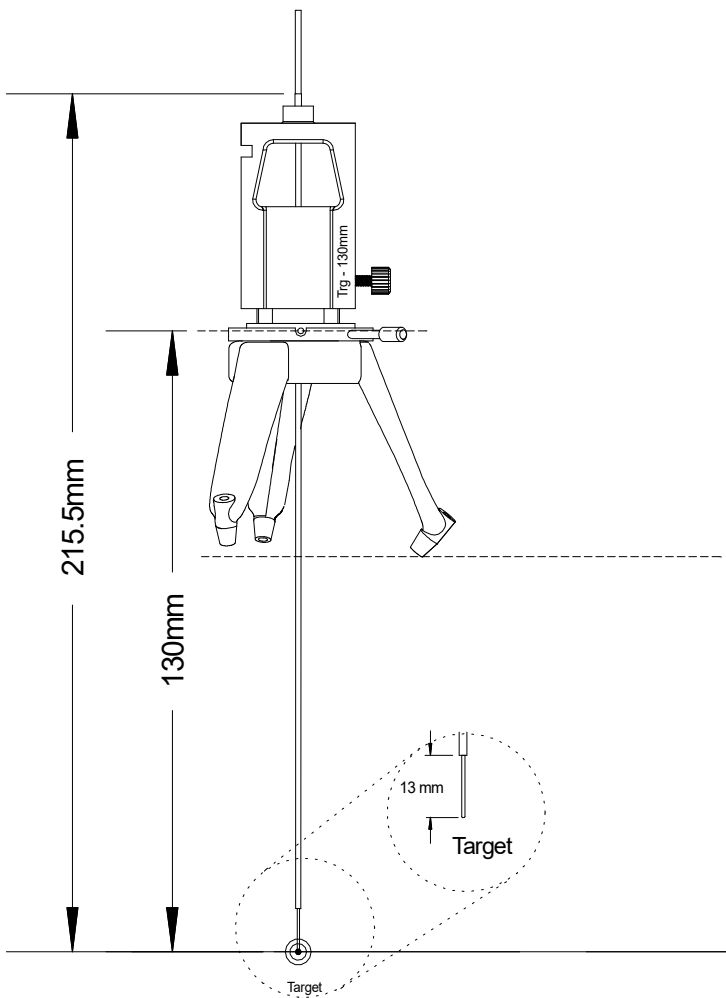

## 40CM Lead Implant

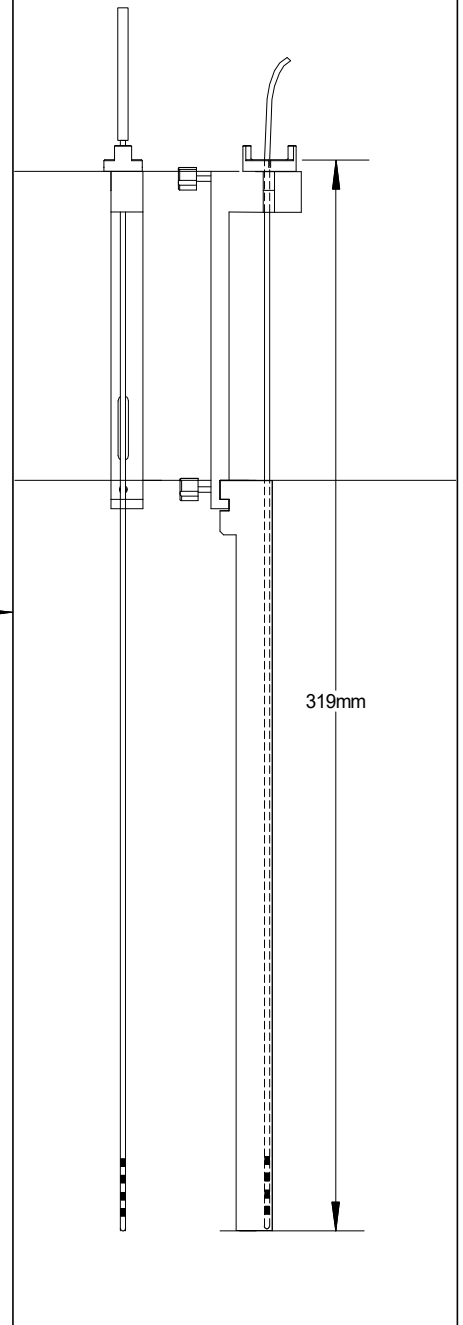



# 120 mm Inserter Extended Clearance-Height Chart

Catalog Number: 66-WP-ID-02  
(Shown with MR Lead Insertion Tube 66-IT-MR1)

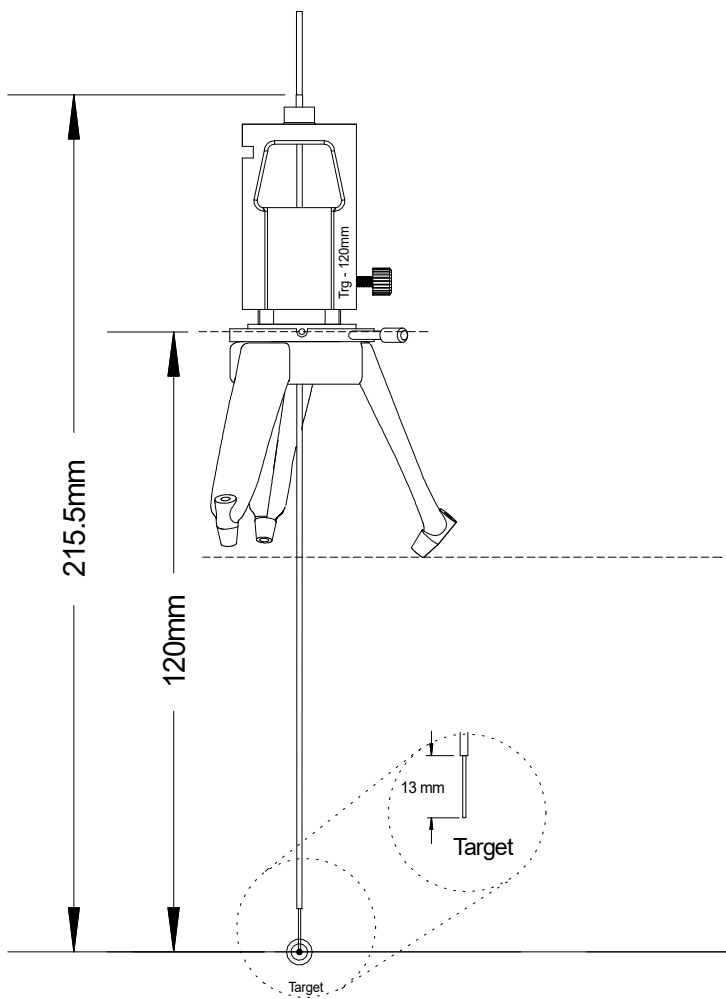

# 40CM Lead Implant

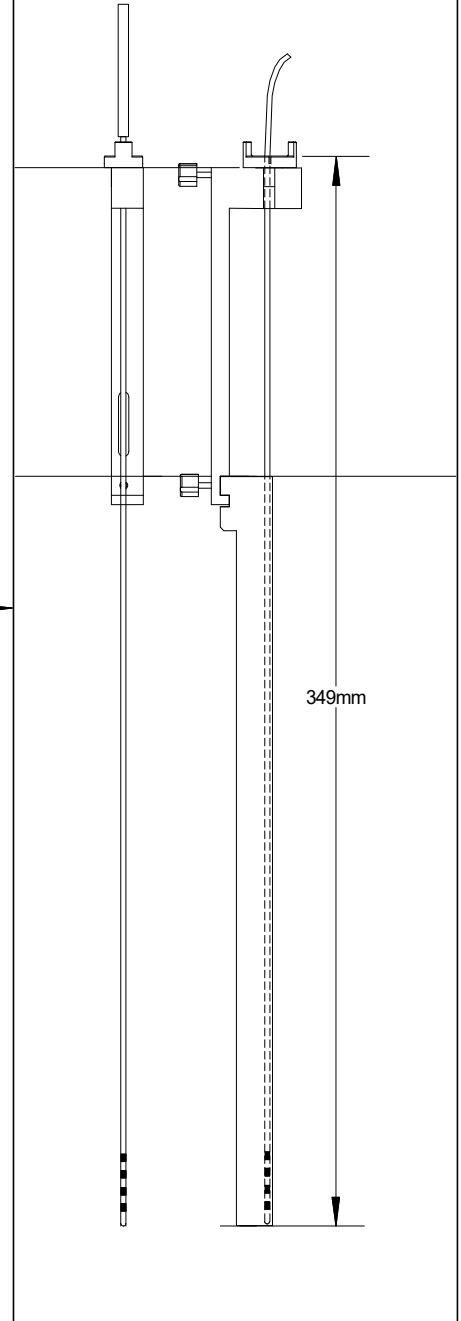

## Pre-Use Check

1. Confirm that there are no contaminants or debris on any of the parts.
2. Confirm all thumbknobs are present. Note that a sterile marking pen may be used to mark the screw heads prior to use, making it easier to differentiate between them during the surgical procedure.



3. Test mount the lead holder on the inserter, confirm there are no stripped threads or looseness.
4. Pull the stylet up 2cm out of the insertion tube. Ensure that the stylet tip retracts into the insertion tube.

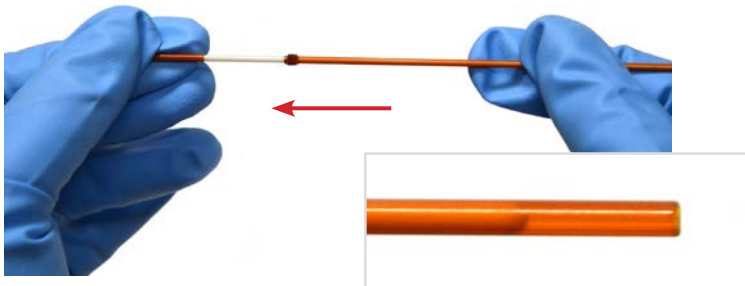
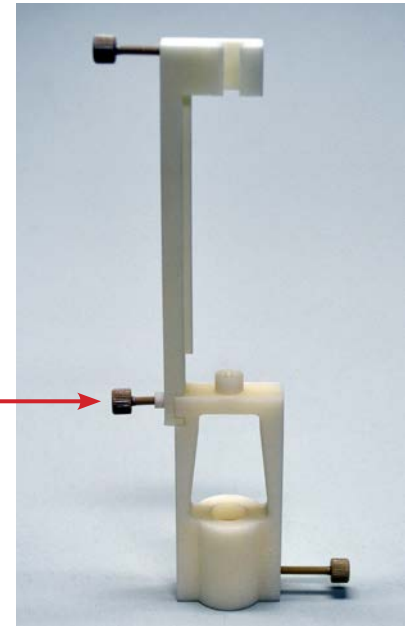

**⚠ WARNING:** Delicate insertion tubes should always be carefully inspected before use because damage to them can cause targeting errors and impact patient safety. Handle insertion tubes carefully to prevent bending.

5. Place the center hub into the integrated indexing ring. Secure the hub with the two indexing ring screws. Ensure correct fit and seat of the hub within the ring. Repeat for the second side for a bilateral platform.



6. Place the two 8mm thumbknobs in the free indexing ring tapped holes and thread them in lightly. Mount the drape support as shown, tightening the thumbknobs until the drape support is held securely.

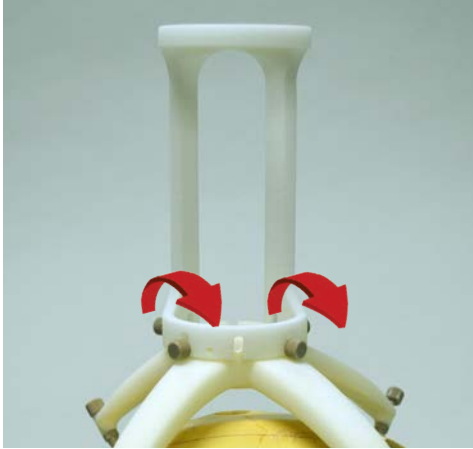

7. Secure the center positioner to the inserter.



8. Install the insertion tube with stylet into the inserter. When the inserter and positioner are mounted on the platform in the center hub, the tip of the stylet will be exactly at the predicted target.
9. Disassemble all parts and lay them out in preparation of the start of the surgery.

## Procedure for MRI Implantation of Lead

1. Attach and hand tighten standoffs to anchors.



2. Mount platform on standoffs using thumbknobs.



**⚠ WARNING:** Delicate insertion tubes should always be carefully inspected before use because damage to them can cause targeting errors and impact patient safety. Handle insertion tubes carefully to prevent bending.

3. Install center hub in indexing ring (built into platform). Ensure that hub thumbknob is positioned 135° from indexing ring thumbknobs. Tighten both indexing ring screws, which should be positioned 90° apart.



4. Insert burr hole marker bushing into center hub.



5. Insert the burr hole marking tool down through the bushing.



6. Create indentation in skin/skull for location of burr hole and remove marking tool.



7. Remove burr hole marker bushing.



8. Remove platform and create burr hole.



9. Reattach platform.



10. Install center positioner in center hub. The tab on the center positioner should be positioned opposite the hub thumbknob. Examine burr hole to ensure entry area is clear. If necessary, remove the center hub and install the entry offset hub.

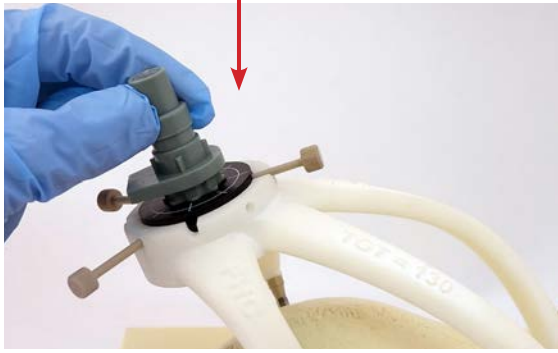

**WARNING:** Incorrect thumbknob orientation may affect targeting accuracy.

**WARNING:** The entry offset hub creates a new trajectory which is orthogonally offset 3mm from original at approximate entry depth, and coincides with the original at the target.

11. Mount inserter on the center positioner and tighten the thumbknob. The thumbknob of the inserter should be in alignment with the tab of the positioner.



**WARNING:** If any error or erratic function is observed, discontinue use of the WayPoint™ Inserter System immediately and evaluate the potential impact to patient safety before continuing its unmitigated use.

**WARNING:** Always confirm the tightness of thumbknobs before beginning the procedure.

**WARNING:** While often snug, all tubes used with the WayPoint™ Inserter System have been designed to be inserted and removed by hand. Any other tool should be used only as a last resort.

12. Insert the MRI safe insertion tube with the stylet in through the center hole. Ensure that the insertion tube enters the brain without hitting the edges of the burr hole.



**WARNING:** The insertion tube will enter the brain at this stage.

**WARNING:** Never move the insertion tube in the brain without a stylet or lead inside.

**WARNING:** The stylet should not be removed until tube is inserted in brain.

**WARNING:** The insertion tube and stylet are fragile and should be handled with care.

**WARNING:** When there is an insertion tube in the brain, every effort should be made to minimize lateral forces to the WayPoint™ Inserter System as it can translate into significant lateral movements of the tube in the brain.

**WARNING:** The insertion tube has no electrical conductivity and cannot be used as an electrical common.

13. Place the two 8mm thumbknobs in the unused indexing ring tapped holes and thread them in lightly.

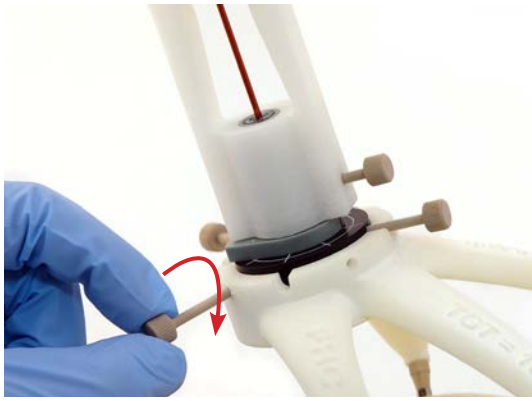

14. Mount the drape support as shown.

Front View



Back View



15. Tighten the 8mm thumbknobs until the drape support is held securely. The thumbknobs should be flush with the outer edge of the drape support.

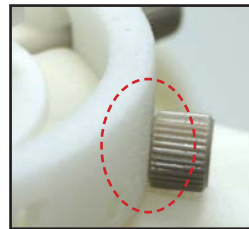





## In the non-MRI Environment

19. Secure lead holder to the DBS measurement fixture.

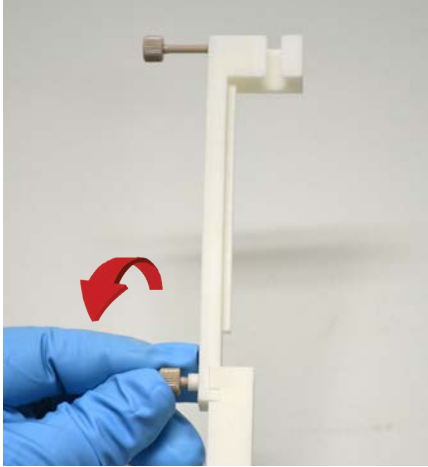

20. Pinch the tabs of the LeadLoc together slightly and slide the distal end of the lead through the top of the LeadLoc to approximately 25 mm from the lead stylet handle, making sure the lead is in the center notch of the LeadLoc.

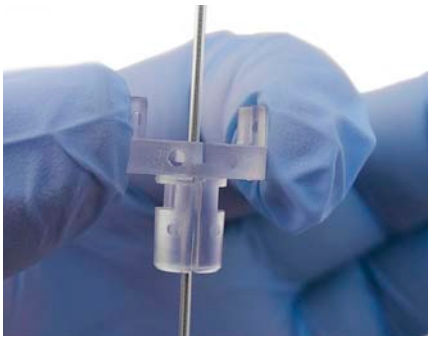

**WARNING:** Do NOT over-pinch the tabs. Over-pinching the tabs could result in the LeadLoc not holding the lead.



**WARNING:** When sliding the lead inside the LeadLoc, ensure the lead is inserted from the top hole down through the bottom hole of the LeadLoc and does not come out of the center slot.

21. Release pressure on the LeadLoc.



22. Insert the lead and the LeadLoc into the lead holder making sure the tabs of the LeadLoc are aligned with the thumbknob on the lead holder. Gently tighten the thumbknob to secure the LeadLoc into the holder then loosen slightly, ensuring that the LeadLoc cannot move vertically.

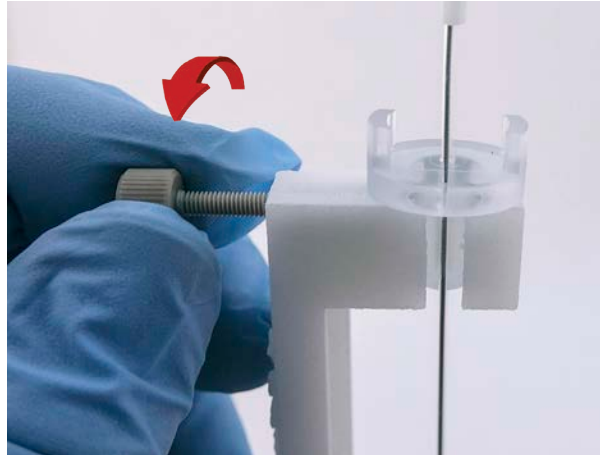

23. While pinching the LeadLoc, move the lead so that the contacts are in the desired position relative to target depth.  
*Note- When using the 120mm inserter, extended clearance, the depth stop will be positioned at  $319 + 30\text{mm}$  as shown in the figure on page 9.*

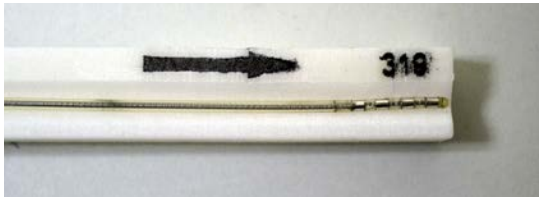

24. Release pressure on the LeadLoc to secure the lead. To confirm the lead does not move during the insertion process, use an appropriate (sterile) pen to make a mark on the lead just above where it comes out of the LeadLoc.
25. Loosen the lead holder and remove from the measuring fixture.

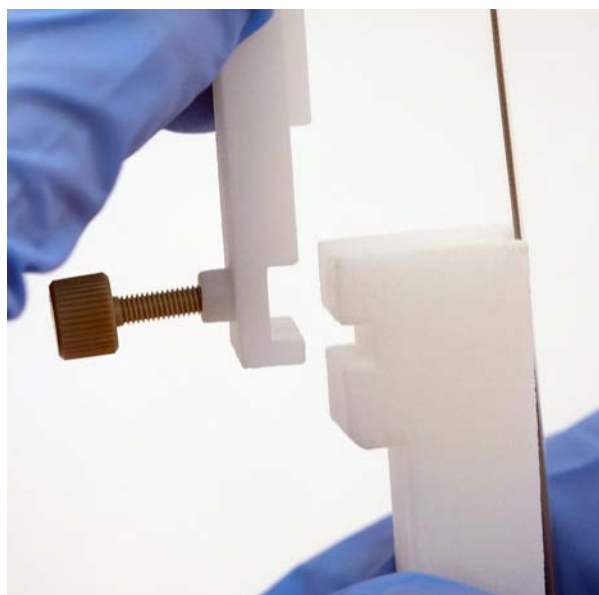

26. Remove the LeadLoc with lead from lead holder.

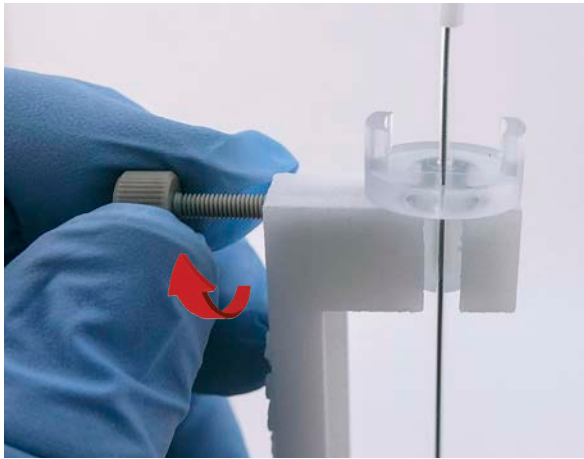

27. Remove drape support by removing the two 8mm thumbknobs and then lifting the drape support straight up.



28. Remove stylet. Be sure to hold the collar of the insertion tube down to prevent movement.

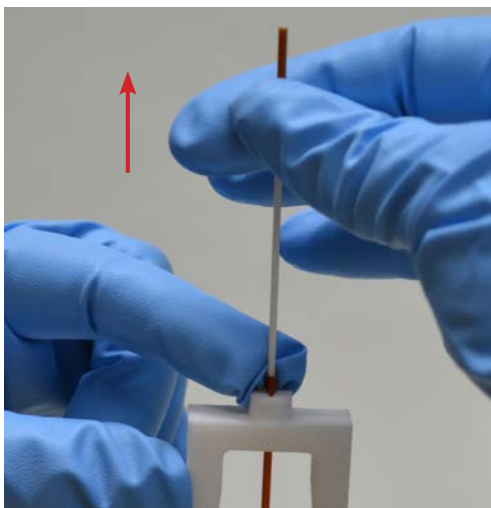

29. Secure the lead holder to the inserter.

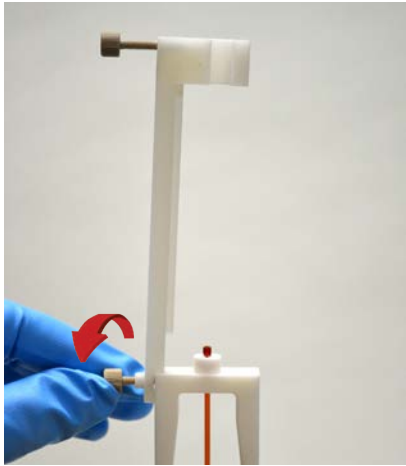

30. Insert the lead through the insertion tube and into the brain. If the center track is not being used, the lead should be placed down through the selected track.

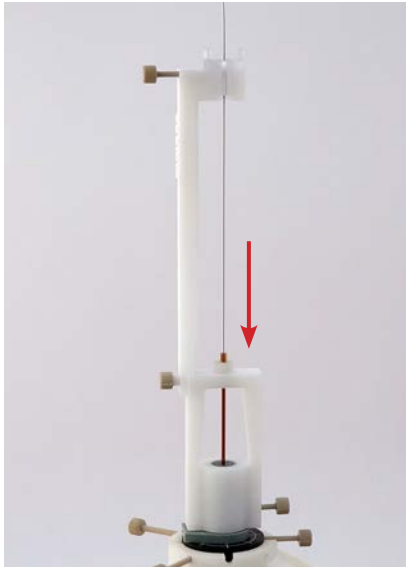

**⚠ WARNING:** Observe the exposed segment of the lead while advancing the inserter and ensure it advances into the insertion tube without binding or bending.

31. Carefully secure the LeadLoc (and lead) in the lead holder making sure the tabs of the LeadLoc align with the thumbknob on the lead holder.

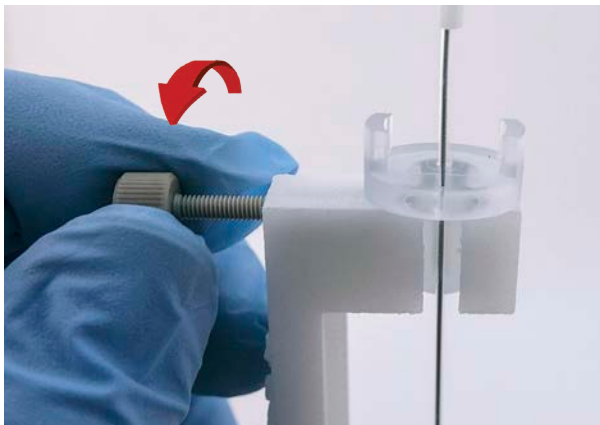

32. Confirm the lead location.
33. Loosen and raise the lead insertion tube out of the skull.

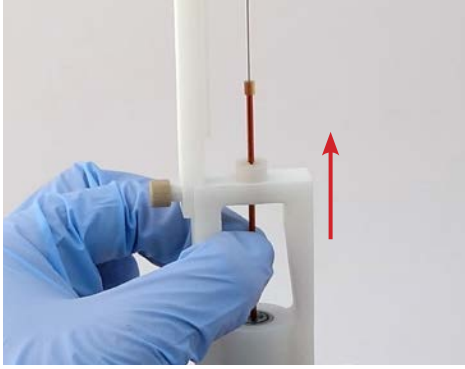

34. Secure the lead next to the skull with smooth tweezers or the selected securing device like Medtronic Navigus cap.
35. Remove the stylet from the lead.
36. Loosen the lead holder thumbknob only slightly, ensuring that it still retains the LeadLoc and that the LeadLoc cannot move vertically.

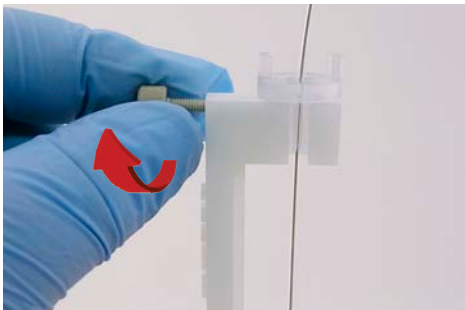

37. Pinch the LeadLoc and pull the lead down through the drive.

**⚠ WARNING:** Trying to pull the LeadLoc over the lead may dislodge the lead from its implantation location.

38. Remove the mounted equipment and the platform.

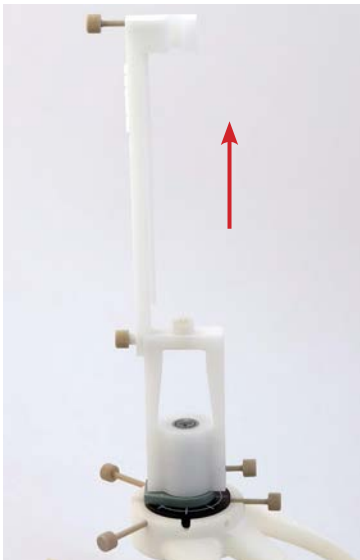

- 39. Remove the standoffs using the standoff wrench.
- 40. Insert the combination driver into the manual handle.



- 41. Place the hex wrench over the first anchor to be removed. Drop the combination driver down into the hex wrench until it engages with the anchor. Twist the hex wrench counterclockwise to remove the anchor.



- 42. Repeat the step above for all remaining anchors.
-  **Disposal:** Dispose of single use items according to Hospital protocol.