



STar™ Drive Adapter Kit for microTargeting™ Platforms With Intergrated Ring

Directions For Use

L011-44 (Rev D1, 2018-12-05)

Contains directions for the following products:

70-FA-SF-01, 66-IT-VP-01, 66-MP-EH, 66-MP-EM

66-MP-IR, 66-MP-MH, 66-MP-TH, 66-WP-SW

70-DP-CS, 70-DP-OS

www.fh-co.com



FHC, Inc.
1201 Main Street
Bowdoin, ME 04287 USA
Fax: +1-207-666-8292



24 hour technical service:
1-800-326-2905 (US & Can)
+1-207-666-8190



FHC Europe
(TERMOBIT PROD srl)
42A Barbu Vacarescu Str, 3rd Fl
Bucharest 020281 Sector 2
Romania

FHC Latin America
Calle 6 Sur Cra 43 A-200
Edificio LUGO Oficina 1406
Medellín-Colombia

Table of Contents

Indications for use, Intended use, and Other devices required	4
Symbol Key	4
Inventory	4
Cleaning and Sterilization	5-6
Illustrative Procedure:	7
Track Selection	9
Track Offsetting Chart	9

Indications for use

STar™ Drive Platform Adapter Kit is intended to be used with commercially available stereotactic systems for neurosurgical procedures which require the accurate positioning of microelectrodes, stimulation electrodes, or other instruments in the brain or nervous system.













Intended use

STar™ Drive Platform Adapter Kit is intended for use by a neurosurgeon in an operating room environment to position and move devices relative to a planned stereotactic system trajectory and target.

Other devices required:

- Compatible navigation software, such as WayPoint™ Navigator
- Patient specific microTargeting™ Platform built using fiducial anchor locations and desired trajectory
- Stereotactic device compatible with surgical kit positioners, such as microTargeting™ STar™ Drive

Symbol Key

	WARNING / Caution, consult instructions for important cautionary information.		Medical device manufacturer, as defined in EU Directives 90/385/EEC, 93/42/EEC and 98/79/EC.
	Consult the instructions for use.		Telephone number
	In reference to "Rx only" symbol; this applies to USA audiences only		Date when the medical device was manufactured
Rx Only	Caution- Federal law (USA) restricts this device to sale by or on the order of a physician.		Authorized Representative in the European Community
	Indicates the catalog number so that the medical device can be identified.		European Conformity. This device fully complies with MDD Directive 93/42/EEC and legal responsibilities as a manufacturer are with FHC, Inc., 1201 Main Street, Bowdoin, ME 04287 USA.
	Indicates the manufacturer's batch code so that the batch or lot can be identified.		An item that is known to pose hazards in all MRI environments.
	Indicates the serial number so that a specific medical device can be identified.		

Inventory

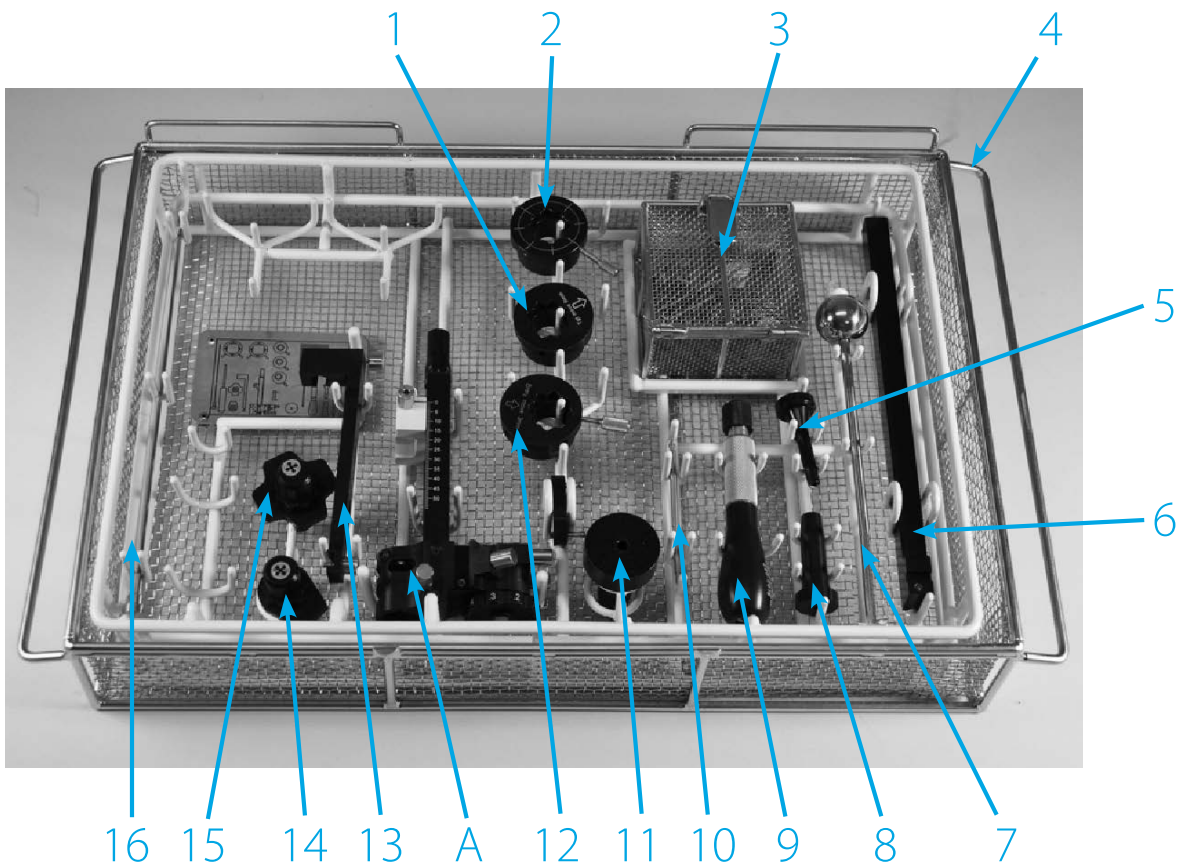

1.	6mm Target Offset Mounting Hub	66-MP-TH
2.	Standard Mounting Hub	66-MP-MH
3.	Microtray for small parts	
4.	SteriSuite Case	67-00-7
5.	Hex Wrench	66-WP-HW
6.	Lead Measuring Fixture	66-AC-MT-01
7.	Entry Marking Tool	66-MP-EM
8.	Standoff Wrench	66-WP-SW
9.	Manual Handle	66-MP-DH
10.	Combination Bit	66-WP-CD
11.	Burr hole Bushing	66-MP-EM
12.	3mm Entry Offset Mounting Hub	66-MP-EH
13.	Lead Holder	70-CN-DB
14.	Center positioner	70-DP-CS
15.	Offset Positioner	70-DP-OS
16.	Verification Probe	66-IT-VP-01

Purchased Separately

A.	STar™ Drive M/E (shown) or STar™ Drive M/A	Various
----	--------------------------------------------	---------

* or STar™ Drive sold in kits

Cleaning and Sterilization

Manual Cleaning Protocol: (Requires STar™ SteriSuite)

1. Prepare the detergent according to manufacturer's recommendations: Asepti Wash Plus liquid (2.5 ml per liter or 1/4 oz per gal), using warm tap water.
2. Separate the Drive, positioners, hubs, and Lead Holder and immerse them in the wash solution for a minimum of 5 minutes. Actuate the devices during the soak.
3. Using a clean soft cloth that has been soaked in the detergent, wipe the tray, and its insert, to remove any visible soil. Use a soft bristle brush and syringe to reach hard-to-clean areas.
4. Place the Drive and its components back in the tray.
5. Prepare the detergent in a sonication unit according to manufacturer's recommendations: Asepti Wash Plus liquid (2.5 ml per liter or 1/4 oz per gal).
6. Immerse the tray in the sonication unit and sonicate for a minimum of 10 minutes.
7. Rinse all components with running reverse osmosis/de-ionized water to remove any residual detergent.
8. Dry components using a clean soft cloth.
9. Visually inspect to ensure all visible soil is removed.

Automated Cleaning Protocol: (Requires STar™ SteriSuite)

Phase	Recirculation Time (min)	Water Temperature	Ecolab Inc. Detergent (2.5 ml/l or 1/4 oz/gal)	Ecolab Inc. Detergent (2.5 ml/l or 1/4 oz/gal)
Pre-Wash 1	2:00	Cold Tap Water (16°C max)	N/A	N/A
Enzyme Wash	2:00	Hot Tap Water (43°C min)	Asepti Wash Plus	Sekusept AR
Wash 1	2:00	65.5°C (Set Point)	Asepti Wash Plus	Sekusept AR
Rinse 1	2:00	Heated Water (66.0°C)	N/A	N/A
Pure Water Rinse	0:10	Heated (66.0°C)	Asepti Rinse	Sekusept FNZ or Sekumatic Multiclean
Dry Phase	7:00	115°C	N/A	N/A

Platform Adapter Kit Sterilization instructions:

Method	Protocol	
Steam	Gravity wrapped: (in 2 Layers of 1-ply Polypropylene wrap ^[1]) Exposure Time: 30 minutes at 132°C (270°F) Minimum Dry Time: 60 minutes [1] Cycle was validated using Halyard Health H300 wrap	Prevacuum wrapped: (in 2 Layers of 1-ply Polypropylene wrap ^[2]) Preconditioning Pulses: 3 Exposure Time: 4 minutes at 132°C (270°F) Minimum Dry Time: 60 minutes [2] Cycle was validated using Halyard Health H400 wrap
	Gravity wrapped: (in 2 Layers of 1-ply Polypropylene wrap ^[3]) Preconditioning Pulses: 3 Exposure Time: 18 minutes at 134°C (273°F) Minimum Dry Time: 60 minutes [3] Cycle was validated using Halyard Health H300 wrap	

 Users should be aware that the effects of unvalidated sterilization protocols could result in damage to the components and affect their functioning or performance. The STar™ Drive Adapter Kit is not validated for use with alternative sterilization protocols, and FHC does not recommend or endorse their use. Users with questions regarding this safety issue should contact FHC's Technical Service Department at 1-207-666-8190.

Illustrative Procedure

1. Attach and handtighten standoffs to anchors.

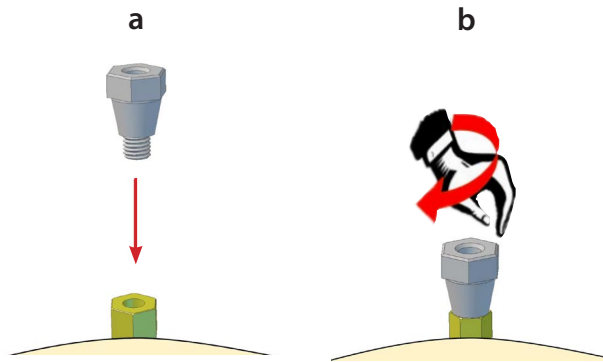

2. Attach platform to standoffs with thumbknobs.

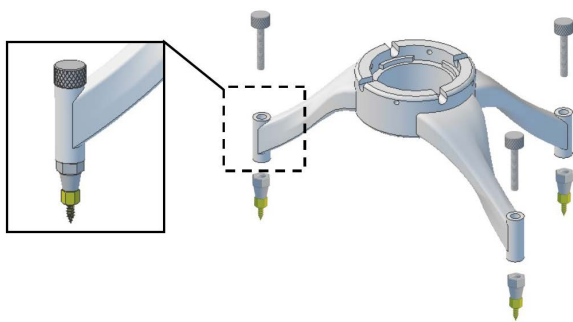

⚠ WARNING: Do not overtighten thumbknobs. Only turn an additional 1/4 turn after contacting mating surface.

3. Attach the center hub to the platform using 2 screws at 90 degrees apart. Make sure the hub is completely seated in the platform. The hub will sit approximately 1/8" above the top surface of the platform.

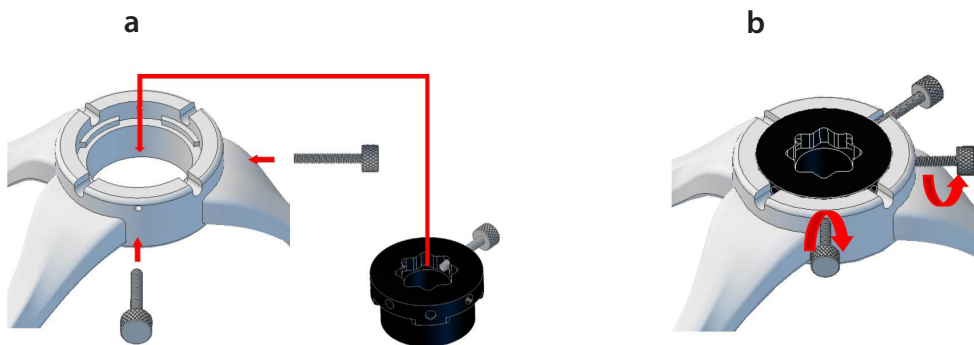

4. Use the burr hole entry marker with burr hole bushing and mark the skin and skull, then remove.

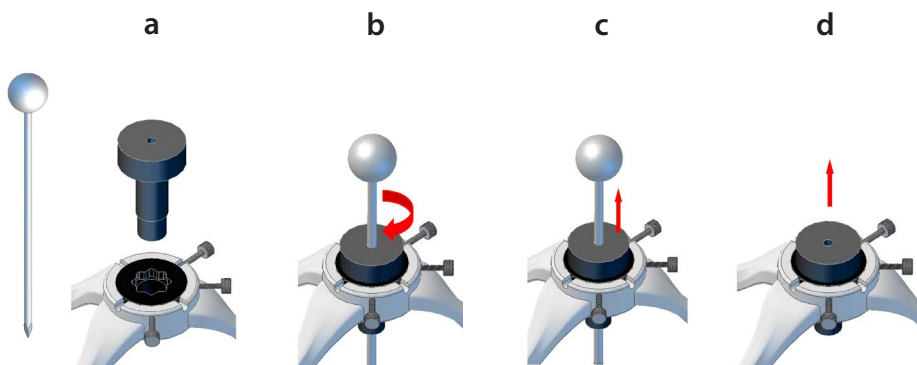

5. Remove platform and drill burr hole.
6. Reattach platform.
7. Attach center drive positioner to center hub with tab oriented 45°, 90°, or 135° relative to screw. Make sure positioner is completely seated in the hub.

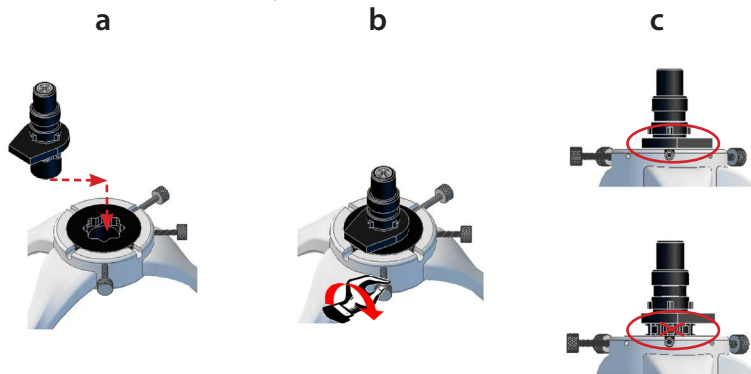

8. Attach drive to positioner and secure following drive instructions.
9. Perform MER and implant lead.
10. Remove drive from positioner, then remove platform.
11. Use the standoff wrench to support the standoff while twisting the driver clockwise to secure it to the standoff. Turn standoff wrench counterclockwise to remove standoff.

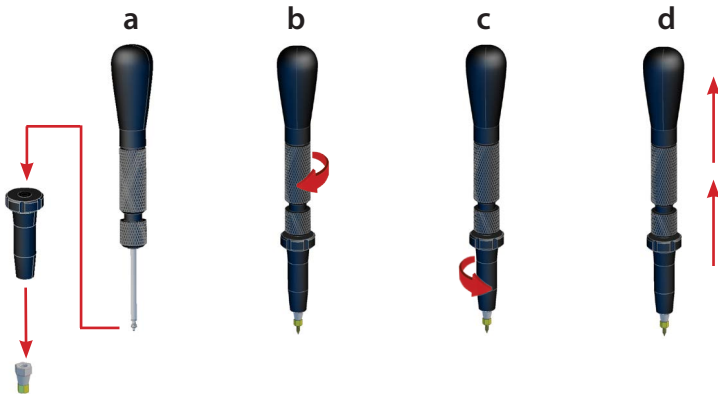

12. Use the anchor wrench to support the anchor while twisting the driver clockwise to secure it to the anchor. Turn anchor wrench counterclockwise to remove anchor.

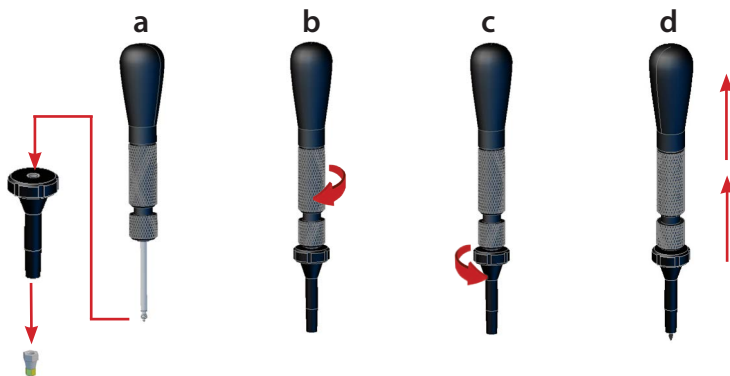

13. Dispose of used anchors, Standoffs and thumbknobs according to hospital protocol.

Track Selection

Center positioner (9 distinct tracks): Center track on target. Four parallel tracks with 2mm offset, '+' configuration, using positions A, C, E and G. Four parallel tracks with 2mm offset, 'x' configuration, using positions B, D, F and H.

Examples:

Center Positioner, '+' configuration, using any of positions A, C, E or G, indicated by the black dots in the offsetting chart below.

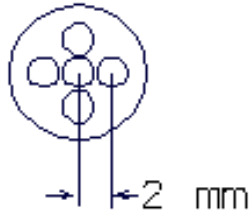

Center Positioner, 'X' configuration, using any of positions B, D, F or H, indicated by the red dots in the offsetting chart.

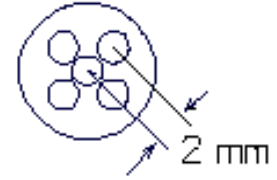

3mm offset positioner (40 distinct tracks): Five parallel tracks with 2mm offset, center track offset 3mm from origin, in eight configurations using positions A-H.

Examples:

3mm Offset Positioner in the 'G' position, indicated by the dark blue dots in the offsetting chart.

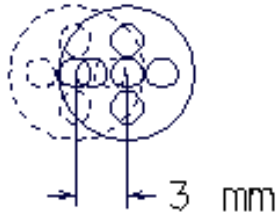

3mm Offset Positioner in the 'B' position, indicated by the magenta dots in the offsetting chart.

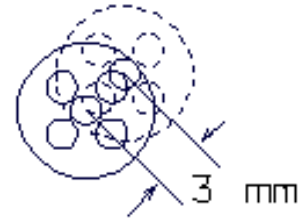

Offsets beyond the 10mm range of the positioner may be reached with the target offset hub.

Track Offsetting Chart

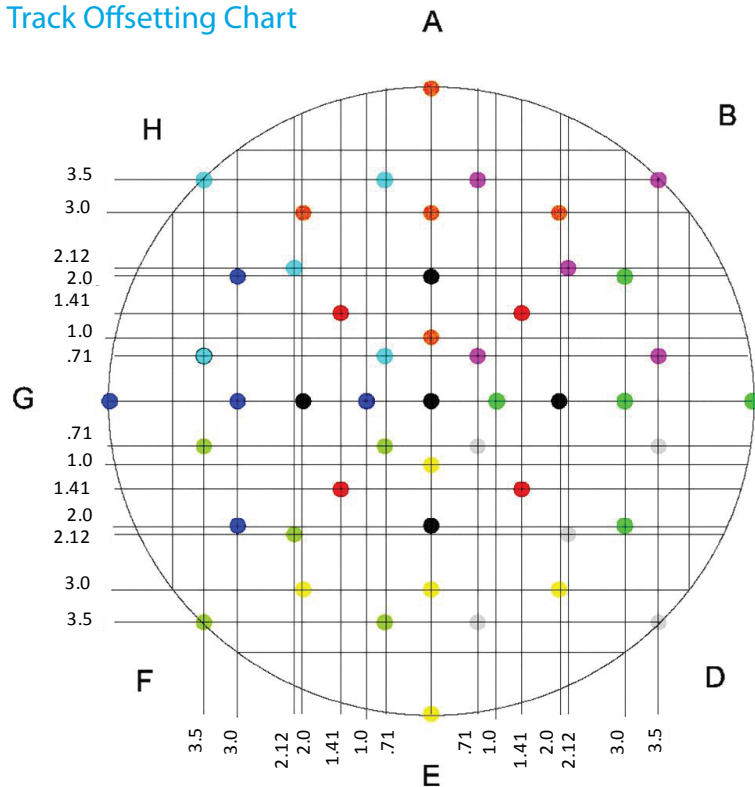

⚠ WARNING: The target offset hub creates a new trajectory with target area orthogonally offset 6mm from the original at the microelectrode tip depth when the physical drive reads 30mm. For platforms with $T <> 30$, the offset of 0.69mm per 10mm of drive travel may be used to determine position at target depth.

C ⚠ WARNING: The entry offset hub creates a new trajectory which is orthogonally offset 3mm from original at approximate entry depth, and coincides with the original at the microelectrode tip depth when the physical drive reads 30mm. For platforms with $T <> 30$, the offset of 0.34mm per 10mm of drive travel may be used to determine position at target depth.

